

GaAlAs-IR-Lumineszenzdiode (880 nm) und Si-Fototransistor
GaAlAs-Infrared-Emitter (880 nm) and Si-Phototransistor
Lead (Pb) Free Product - RoHS Compliant

SFH 7221



Wesentliche Merkmale

- SMT-Gehäuse mit IR-Sender (880 nm) und Si-Fototransistor
- Geeignet für SMT-Bestückung
- Gegurtet lieferbar
- Sender und Empfänger getrennt ansteuerbar

Anwendungen

- Datenübertragung
- Wegfahrsperrung
- Infrarotschnittstelle

Features

- SMT package with IR emitter (880 nm) and Si-phototransistor
- Suitable for SMT assembly
- Available on tape and reel
- Emitter und detector can be controlled separately

Applications

- Data transmission
- Lock bar
- Infrared interface

Typ Type	Bestellnummer Ordering Code	Gehäuse Package
SFH 7221	Q65110A2741	SMT Multi TOPLED®

Grenzwerte
Maximum Ratings

Bezeichnung Parameter	Symbol Symbol	Wert Value		Einheit Unit
		IRED	Transistor	
Betriebstemperatur Operating temperature range	T_{op}	- 40 ... + 100	- 40 ... + 100	°C
Lagertemperatur Storage temperature range	T_{stg}	- 40 ... + 100	- 40 ... + 100	°C
Sperrschichttemperatur Junction temperature	T_j	+ 100	+ 100	°C
Durchlassstrom (LED) Forward current (LED)	I_F	100	-	mA
Kollektorstrom (Transistor) Collector current (Transistor)	I_C	-	15	mA
Stoßstrom Surge current $t \leq 10 \mu s, D = 0.005$	I_{FM}	2500	75	mA
Sperrspannung (LED) Reverse voltage (LED)	V_R	5	-	V
Kollektor-Emitter Spannung (Transistor) Collector-emitter voltage (Transistor)	V_{CE}	-	35	V
Verlustleistung Total power dissipation	P_{tot}	180	165	mW
Wärmewiderstand Sperrschicht / Umgebung Thermal resistance junction / ambient Montage auf PC-Board ¹⁾ (Padgröße $\geq 16 \text{ mm}^2$) mounting on pcb ¹⁾ (pad size $\geq 16 \text{ mm}^2$)	$R_{th JA}$	500	450	K/W
Sperrschicht / Lötstelle junction / soldering joint	$R_{th JS}$	400	-	K/W

¹⁾ PC-board: G30/FR4

Hinweis / Notes

Die angegebenen Grenzdaten gelten für einen Chip.
The stated maximum ratings refer to one chip.

Kennwerte IRED ($T_A = 25\text{ °C}$)

Characteristics IRED

Bezeichnung Parameter	Symbol Symbol	Wert Value	Einheit Unit
Wellenlänge der Strahlung Wavelength of radiation $I_F = 100\text{ mA}$, $t_p = 20\text{ ms}$	λ_{peak}	880	nm
Spektrale Bandbreite bei 50% von I_{max} , $I_F = 100\text{ mA}$ Spectral bandwidth at 50% of I_{max} , $I_F = 100\text{ mA}$	$\Delta\lambda$	80	nm
Abstrahlwinkel Viewing angle	φ	± 60	Grad deg.
Aktive Chipfläche Active chip area	A	0.09	mm ²
Abmessungen der aktiven Chipfläche Dimensions of active chip area	$L \times B$ $L \times W$	0.3×0.3	mm ²
Schaltzeiten, I_e von 10% auf 90% und von 90% auf 10% Switching times, I_e from 10% to 90 % and from 90% to 10% $I_F = 100\text{ mA}$, $R_L = 50\ \Omega$	t_r , t_f	0.5	μs
Kapazität Capacitance $V_R = 0\text{ V}$, $f = 1\text{ MHz}$	C_o	15	pF
Durchlassspannung Forward voltage $I_F = 100\text{ mA}$, $t_p = 20\text{ ms}$ $I_F = 1\text{ A}$, $t_p = 100\ \mu\text{s}$	V_F V_F	1.5 (≤ 1.8) 3.0 (≤ 3.8)	V V
Sperrstrom Reverse current $V_R = 5\text{ V}$	I_R	0.01 (≤ 1)	μA
Gesamtstrahlungsfluss Total radiant flux $I_F = 100\text{ mA}$, $t_p = 20\text{ ms}$	Φ_e	23	mW
Temperaturkoeffizient von I_e bzw. Φ_e Temperature coefficient of I_e bzw. Φ_e $I_F = 100\text{ mA}$, $I_F = 100\text{ mA}$	TC_1	- 0.5	%/K

Kennwerte IRED ($T_A = 25\text{ °C}$)
Characteristics IRED (cont'd)

Bezeichnung Parameter	Symbol Symbol	Wert Value	Einheit Unit
Temperaturkoeffizient von V_F Temperature coefficient of V_F $I_F = 100\text{ mA}$	TC_V	- 2	mV/K
Temperaturkoeffizient von λ Temperature coefficient of λ $I_F = 100\text{ mA}$	TC_λ	+ 0.25	nm/K

Strahlstärke I_e in Achsrichtung

 gemessen bei einem Raumwinkel $\Omega = 0.01\text{ sr}$
Radiant Intensity I_e in Axial Direction

 at a solid angle of $\Omega = 0.01\text{ sr}$

Bezeichnung Parameter	Symbol Symbol	Werte Values	Einheit Unit
Strahlstärke Radiant intensity $I_F = 100\text{ mA}$, $t_p = 20\text{ ms}$	I_e	> 4	mW/sr
Strahlstärke Radiant intensity $I_F = 1\text{ A}$, $t_p = 100\text{ }\mu\text{s}$	$I_{e\text{ typ.}}$	48	mW/sr

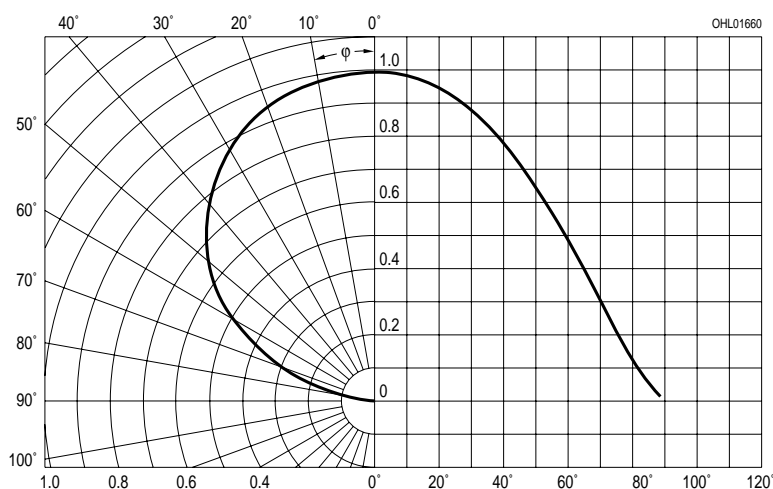
IRED Radiation Characteristics $I_{\text{rel}} = f(\varphi)$
Phototransistor Directional Characteristics $S_{\text{rel}} = f(\varphi)$

Kennwerte Fototransistor ($T_A = 25\text{ °C}$, $\lambda = 880\text{ nm}$)**Characteristics Phototransistor**

Bezeichnung Parameter	Symbol Symbol	Wert Value	Einheit Unit
Wellenlänge der max. Fotoempfindlichkeit Wavelength of max. sensitivity	$\lambda_{S\text{ max}}$	990	nm
Spektraler Bereich der Fotoempfindlichkeit $S = 10\%$ von S_{max} Spectral range of sensitivity $S = 10\%$ of S_{max}	λ	440 ... 1150	nm
Bestrahlungsempfindliche Fläche ($\varnothing 240\text{ }\mu\text{m}$) Radiant sensitive area ($\varnothing 240\text{ }\mu\text{m}$)	A	0.038	mm^2
Abmessung der Chipfläche Dimensions of chip area	$L \times B$	0.45×0.45	$\text{mm} \times \text{mm}$
Abstand Chipoberfläche zu Gehäuseoberfläche Distance chip front to case surface	H	0.5 ... 0.7	mm
Halbwinkel Half angle	φ	± 60	Grad deg.
Kapazität Capacitance $V_{\text{CE}} = 0\text{ V}$, $f = 1\text{ MHz}$, $E = 0$	C_{CE}	5.0	pF
Dunkelstrom Dark current $V_{\text{CE}} = 25\text{ V}$, $E = 0$	I_{CEO}	1 (≤ 200)	nA
Fotostrom Photocurrent $E_e = 0.1\text{ mW/cm}^2$, $V_{\text{CE}} = 5\text{ V}$	I_{PCE}	≥ 16	μA
Anstiegszeit/Abfallzeit Rise time/Fall time $I_{\text{C}} = 1\text{ mA}$, $V_{\text{CC}} = 5\text{ V}$, $R_{\text{L}} = 1\text{ k}\Omega$	t_r, t_f	7	μs
Kollektor-Emitter-Sättigungsspannung Collector-emitter saturation voltage $I_{\text{C}} = 5\text{ }\mu\text{A}$, $E_e = 0.1\text{ mW/cm}^2$	V_{CEsat}	150	mV

URED

Forward Current $I_F = f(V_F)$
 $T_A = 25\text{ }^\circ\text{C}$

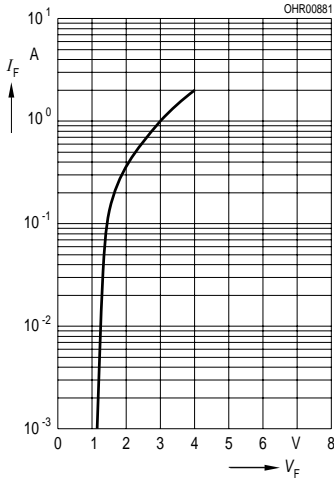

Rel Luminous Intensity
 $I_V / I_V(10\text{ mA}) = f(I_F), T_A = 25\text{ }^\circ\text{C}$

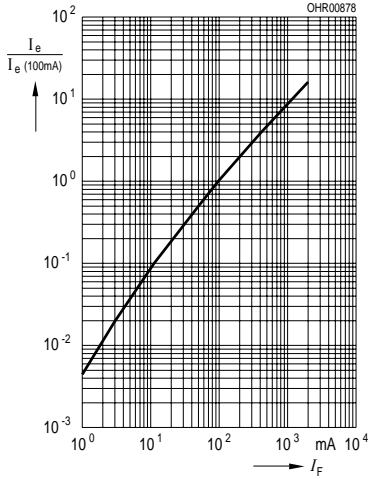

Perm. Pulse Handling Capability
 $I_F = f(t_p)$, Duty cycle $D = \text{parameter}$,
 $T_A = 25\text{ }^\circ\text{C}$

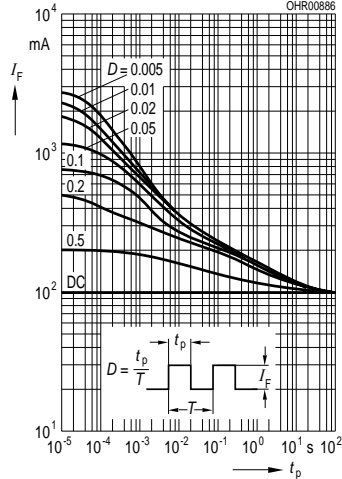

Max. Permissible Forward Current
 $I_F = f(T_A)$

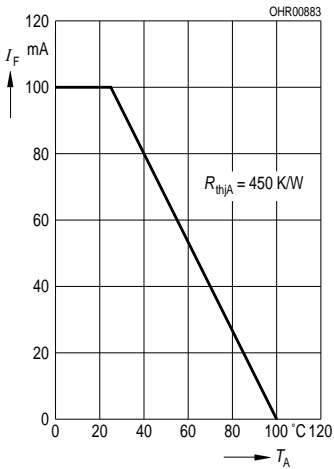

Relative Spectral Emission
 $I_{rel} = f(\lambda)$

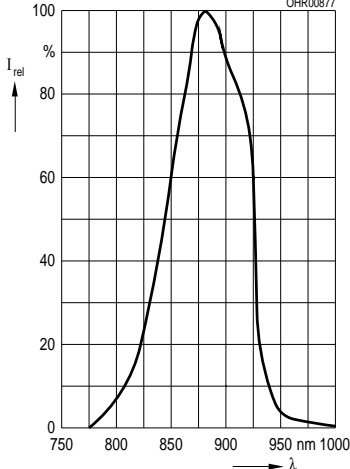

Perm. Pulse Handling Capability
 $I_F = f(t_p)$, Duty cycle $D = \text{parameter}$,
 $T_A = 85\text{ }^\circ\text{C}$

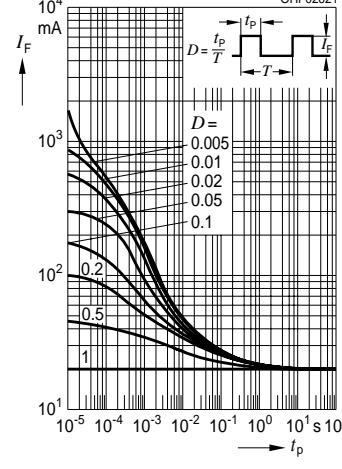

Phototransistor

Rel. Spectral Sensitivity

$S_{rel} = f(\lambda)$

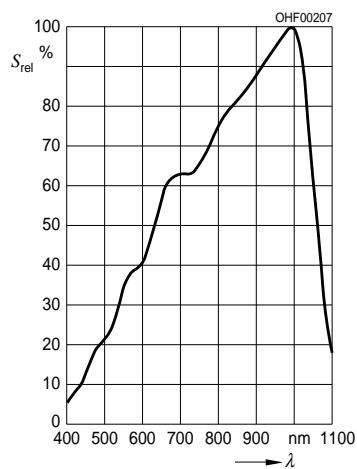

Photocurrent $I_{PCE} = f(V_{CE})$, $E_e = \text{Parameter}$

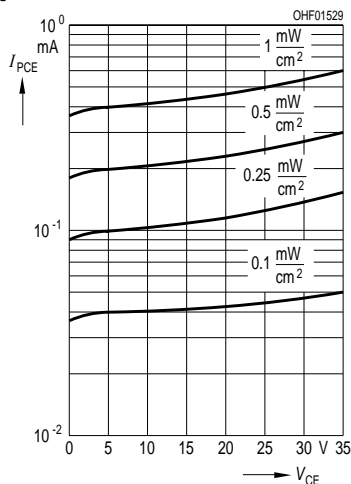

Dark Current

$I_{CEO} = f(V_{CE}), E = 0$

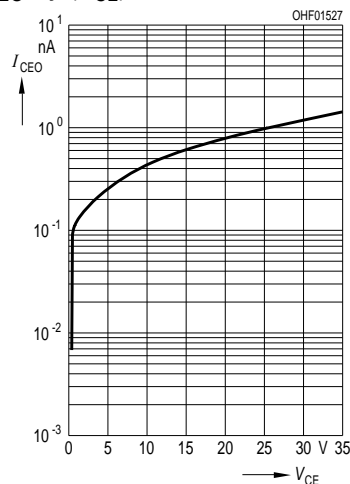

Total Power Dissipation

$P_{tot} = f(T_A)$

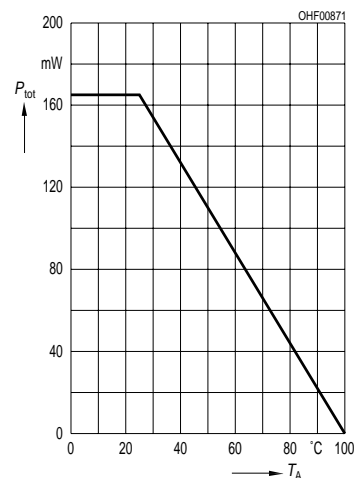

Capacitance

$C_{CE} = f(V_{CE}), f = 1 \text{ MHz}, E = 0$

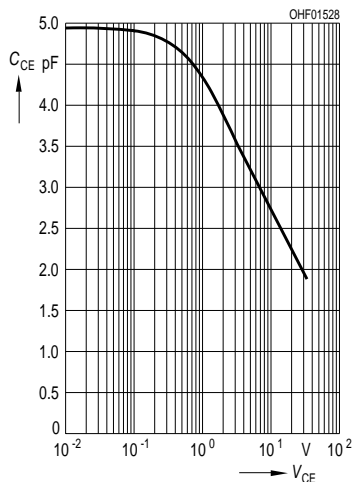

Photocurrent $I_{PCE}/I_{PCE25^\circ} = f(T_A)$, $V_{CE} = 5 \text{ V}$

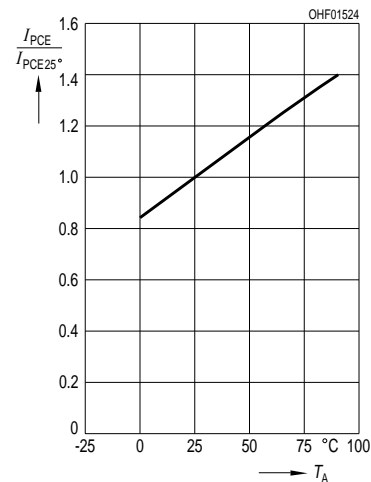

Dark Current

$I_{CEO} = f(T_A), V_{CE} = 5 \text{ V}, E = 0$

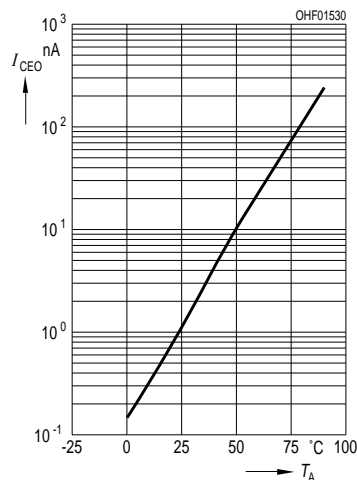

Photocurrent

$I_{PCE} = f(E_e), V_{CE} = 5 \text{ V}$

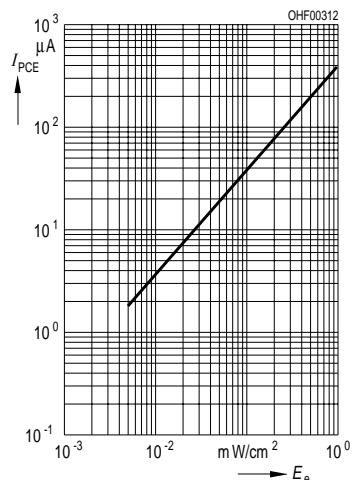

**Maßzeichnung
Package Outlines**

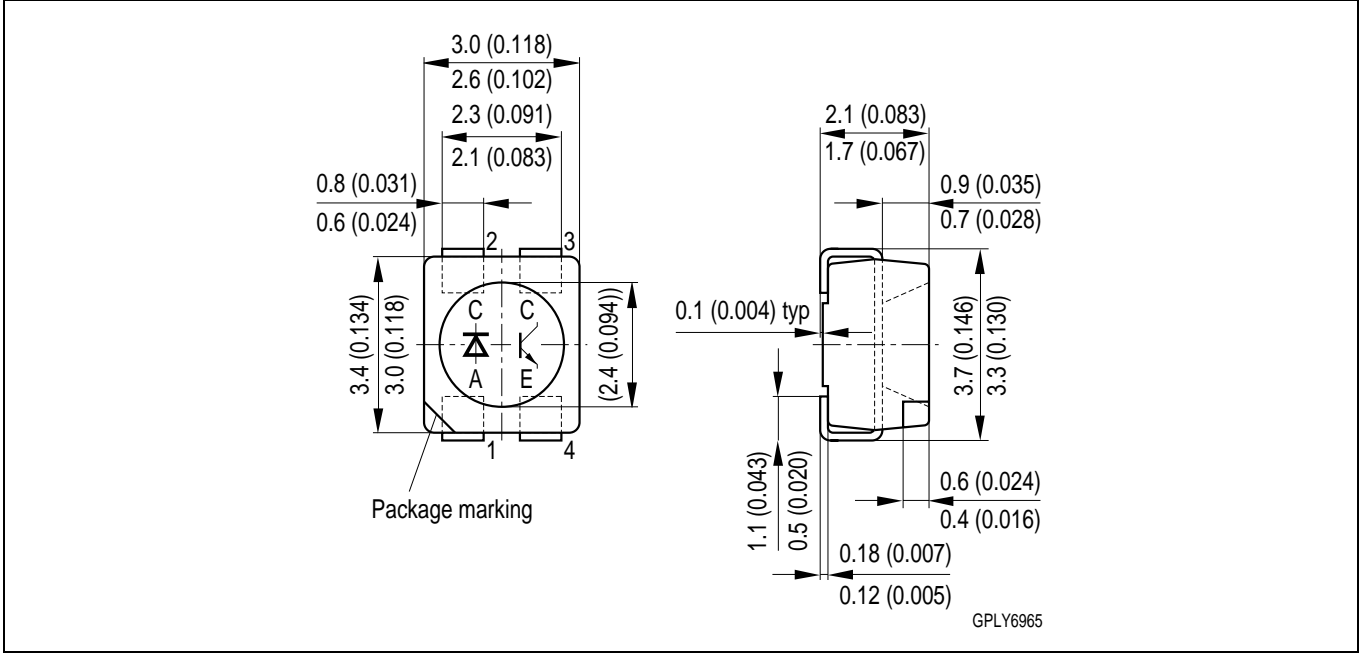

Maße in mm (inch) / Dimensions in mm (inch).

**Empfohlenes Lötpad design
Recommended Solder Pad**

**Reflow Löten
Reflow Soldering**

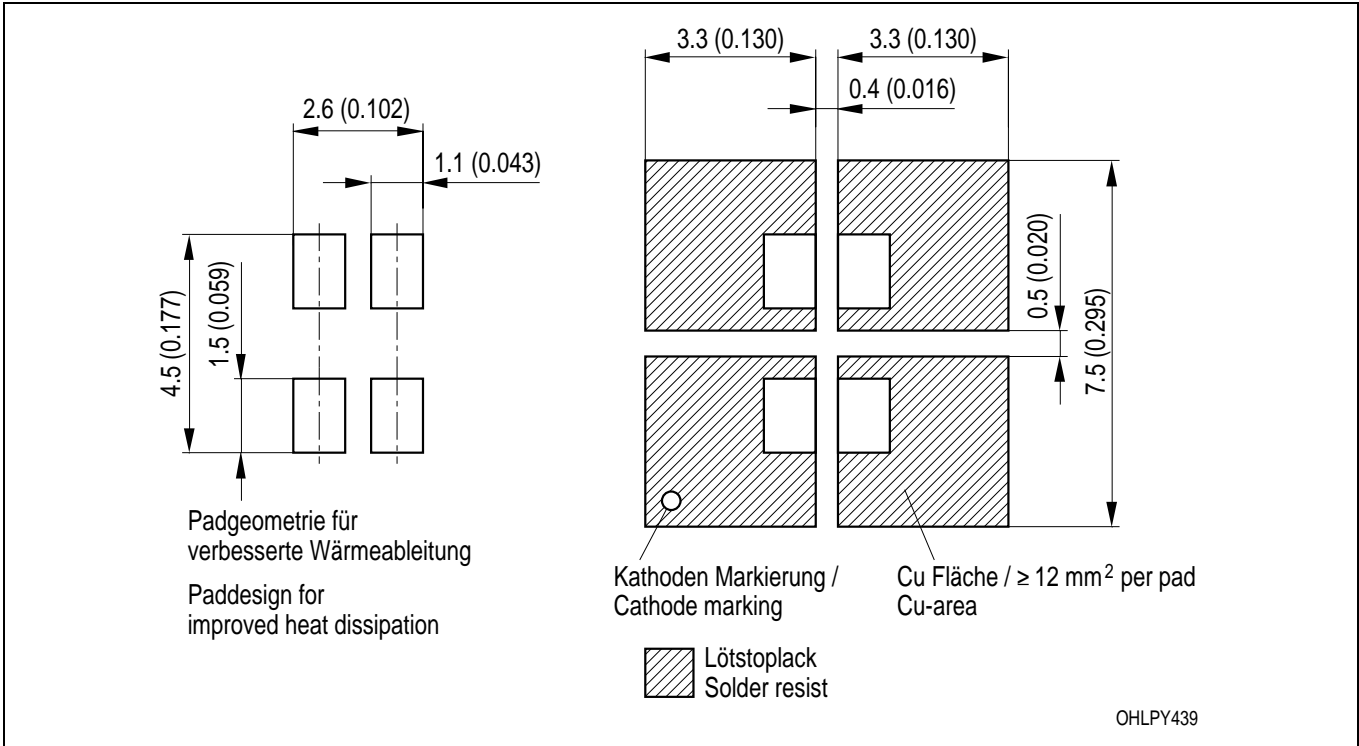

Lötbedingungen
Soldering Conditions
Reflow Lötprofil für bleifreies Löten
Reflow Soldering Profile for lead free soldering

Vorbehandlung nach JEDEC Level 2
 Preconditioning acc. to JEDEC Level 2
 (nach J-STD-020C)
 (acc. to J-STD-020C)

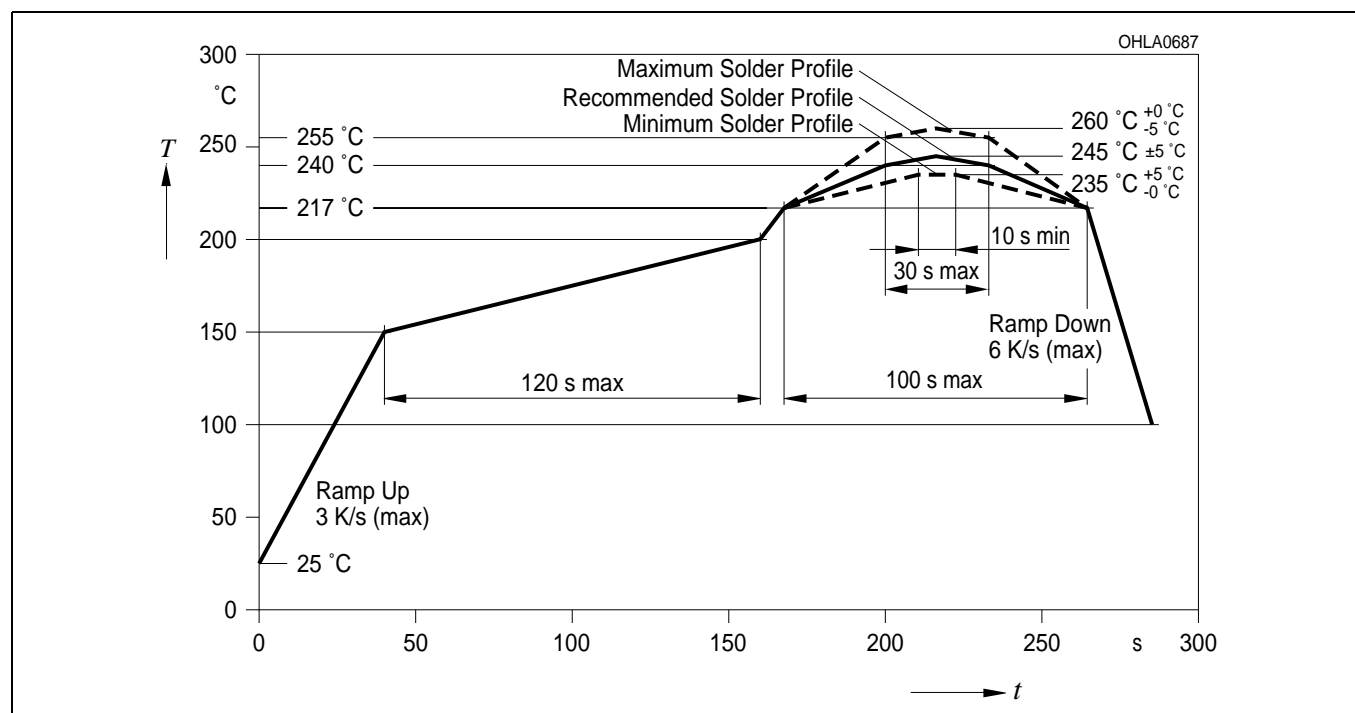

Published by
OSRAM Opto Semiconductors GmbH
 Wernerwerkstrasse 2, D-93049 Regensburg
www.osram-os.com
 © All Rights Reserved.

EU RoHS and China RoHS compliant product



此产品符合欧盟 RoHS 指令的要求；
 按照中国的相关法规和标准，不含有毒有害物质或元素。

The information describes the type of component and shall not be considered as assured characteristics. Terms of delivery and rights to change design reserved. Due to technical requirements components may contain dangerous substances. For information on the types in question please contact our Sales Organization.

Packing

Please use the recycling operators known to you. We can also help you – get in touch with your nearest sales office. By agreement we will take packing material back, if it is sorted. You must bear the costs of transport. For packing material that is returned to us unsorted or which we are not obliged to accept, we shall have to invoice you for any costs incurred.

Components used in life-support devices or systems must be expressly authorized for such purpose! Critical components¹, may only be used in life-support devices or systems² with the express written approval of OSRAM OS.

¹ A critical component is a component used in a life-support device or system whose failure can reasonably be expected to cause the failure of that life-support device or system, or to affect its safety or effectiveness of that device or system.

² Life support devices or systems are intended (a) to be implanted in the human body, or (b) to support and/or maintain and sustain human life. If they fail, it is reasonable to assume that the health of the user may be endangered.

Mouser Electronics

Related Product Links

[720-SFH7221-Z - Osram Opto Semiconductor SFH 7221-Z](#)